

Hydraulic filtration handbook

Parker Filtration's Handbook of Hydraulic Filtration

aerospace
climate control
electromechanical
filtration
fluid & gas handling
hydraulics
pneumatics
process control
sealing & shielding



ENGINEERING YOUR SUCCESS.



- Consistent quality
- Technical innovation
- Premier customer service

Parker's technical resources provide the best filtration technologies that conform to your requirements. That's why thousands of manufacturers and equipment users around the world rely on Parker Filtration products and people.

Worldwide Sales and Service

Parker Filtration's global reputation as a reliable supplier of superior filtration products is the result of a focused and integrated development and manufacturing system.

Parker Filtration consolidates quality filtration products, manufacturing by process filtration, air and gas filtration and separation, fuel conditioning and filtration, hydraulic and lubrication filtration, fluid power products and fluid condition monitoring equipment into one broad-based range that covers most markets and the majority of applications.

Hydraulic, Lubrication & Coolant Filtration

High-performance filtration systems for production machinery in industrial, mobile and military/marine applications.



Compressed Air & Gas Filtration

Complete line of compressed air/gas filtration products; coalescing, particulate and adsorption filters in many applications in many industries.



Photo courtesy of GLASBAU HAHN.

Process & Chemical Fluid Filtration

Liquid filtration systems for beverage, chemical and food processing; cosmetic, paint, water treatment; photo-processing; and micro-chip fabrication.



Racor Fuel Conditioning & Filtration

Parker air, fuel and oil filtration systems provide quality protection for engines operating in any environment, anywhere in the world.



System Contamination Monitoring

On-line dynamic particle analysis, off-line bottle sampling and fluid analysis and measurement of water content polluting the oil in a system. All important and achievable, cost-effective solutions available to equipment manufacturers and end users alike.

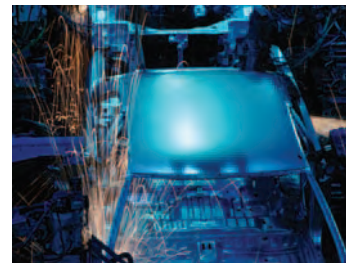

Contents

Contamination Basics	2
Contamination Types & Sources	4
Fluid Cleanliness Standards	12
Filter Media Types & Ratings	16
Filter Media Selection	20
Filter Element Life	22
Filter Housing Selection	24
Types & Locations of Filters	28
Fluid Analysis	32
Appendix	34

Introduction

Parker's Handbook of Hydraulic Filtration is intended to familiarise the user with all aspects of hydraulic and lubrication filtration from the basics to advanced technology.

It is dedicated as a reference source with the intent of clearly and completely presenting the subject matter to the user, regardless of the individual level of expertise.

The selection and proper use of contamination control products is an important tool in the battle to increase production while reducing manufacturing costs. This handbook will help the user make informed decisions about hydraulic filtration.



Contamination Basics

Contamination Causes Most Hydraulic Failures

The experience of designers and users of hydraulic and lube oil systems has verified the following fact: over 85% of all system failures are a direct result of contamination!

The cost due to contamination is staggering, resulting from:

- Loss of production (downtime)
- Component replacement costs
- Frequent fluid replacement
- Costly disposal
- Increased overall maintenance costs
- Increased scrap rate

Filtration Fact

Properly sized, installed, and maintained hydraulic filtration plays a key role in machine preventative maintenance planning.

Functions of Hydraulic Fluid

Contamination interferes with the four functions of hydraulic fluids:

1. To act as an energy transmission medium.
2. To lubricate internal moving parts of components.
3. To act as a heat transfer medium.
4. To seal clearances between moving parts.

If any one of these functions is impaired, the hydraulic system will not perform as designed. The resulting downtime can easily cost a large manufacturing plant thousands of Euro's per hour. Hydraulic fluid maintenance helps prevent or reduce unplanned downtime. This is accomplished through a continuous improvement programme that minimises and removes contaminants.

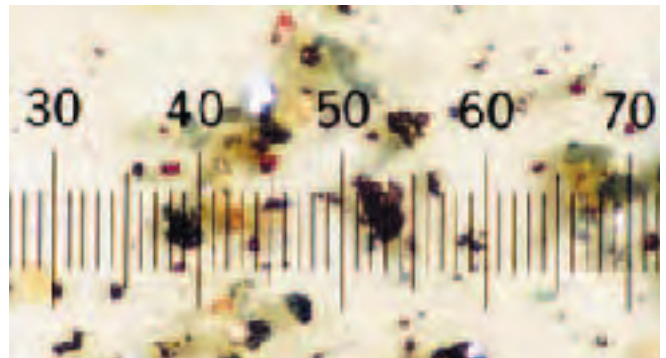

Actual photomicrograph of particulate contamination
(Magnified 100x Scale: 1 division = 20 microns)

Filtration Fact

The function of a filter is to clean oil, but the purpose is to reduce operating costs.

Contaminant Damage

- Orifice blockage
- Component wear
- Formation of rust or other oxidation
- Chemical compound formation
- Depletion of additives and oil degradation

Hydraulic fluid is expected to create a lubricating film to keep precision parts separated. Ideally, the film is thick enough to completely fill the clearance between moving parts. This condition results in low wear rates. When the wear rate is kept low enough, a component is likely to reach its intended life expectancy, which may be millions of pressurisation cycles.

The actual thickness of a lubricating film depends on fluid viscosity, applied load, and the relative speed of the two surfaces. In many components, mechanical loads are to such an extreme that they squeeze the lubricant into a very thin film, less than 1 micrometre thick. If loads become high enough, the film will be punctured by the surface roughness of the two moving parts. The result contributes to harmful friction.



Typical Hydraulic Component Clearances

Component	Microns
Anti-friction bearings	0.5
Vane pump (vane tip to outer ring)	0.5-1
Gear pump (gear to side plate)	0.5-5
Servo valves (spool to sleeve)	1-4
Hydrostatic Bearings	1-25
Piston pump (piston to bore)	5-40
Servo valves flapper wall	18-63
Actuators	50-250
Servo valves orifice	130-450

Micrometre Scale

Relative Sizes of Particles		
Substance	Microns	Inches
Grain of table salt	100	.0039
Human hair	70	.0027
Lower limit of visibility	40	.0016
Milled flour	25	.0010
Red blood cells	8	.0003
Bacteria	2	.0001

Particle sizes are generally measured on the micrometre scale. One micrometre (or “micron”) is one-millionth of one metre, or 39 millionths of an inch. The limit of human visibility is approximately 32µm micrometres. Keep in mind that most damage-causing particles in hydraulic or lubrication systems are smaller than 14µm micrometres. Therefore, they are microscopic and cannot be seen by the unaided eye.

Contamination Types & Sources

Particle Contamination

Types

Particulate contamination is generally classified as “silt” or “chip”. Silt can be defined as the accumulation of particles less than $5\mu\text{m}$ over time. This type of contamination also causes system component failure over time. Chips on the other hand, are particles $5\mu\text{m}+$ and can cause immediate catastrophic failure. Both silt and chips can be further classified as:

Hard Particles

- Silica
- Carbon
- Metal

Soft Particles

- Rubber
- Fibres
- Micro Organism

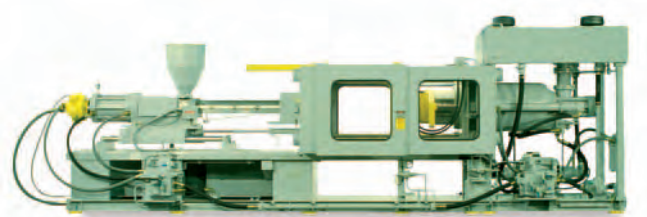
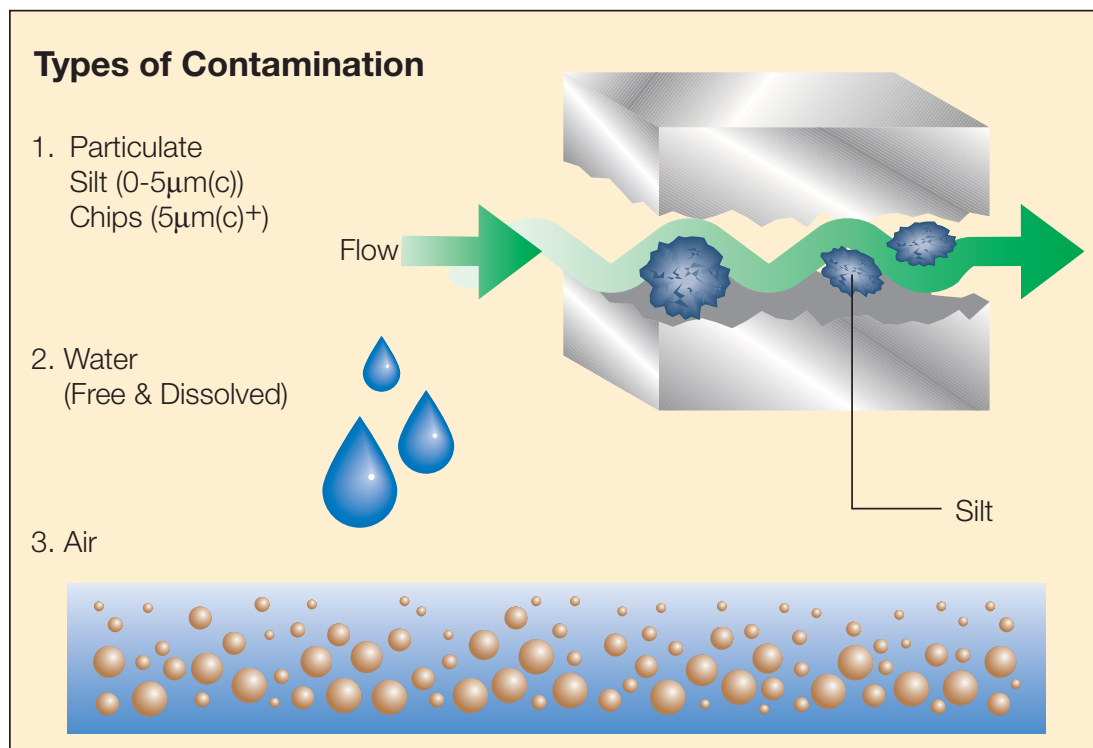

Filtration Fact

Additives in hydraulic fluid are generally less than 1 micron and are unaffected by standard filtration methods.

Contamination Types & Sources

External Contamination Sources

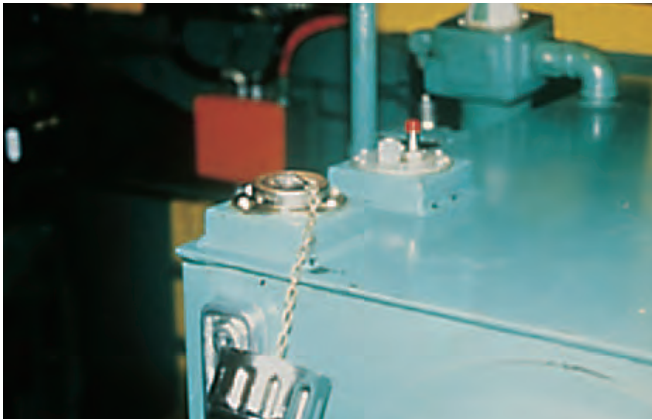
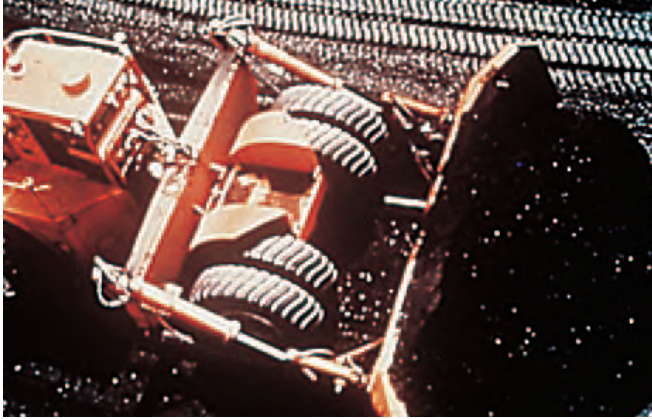

Ingression rates for Typical Systems	
System	Ingression Rate
Mobile Equipment	10^8 - 10^{10} per minute*
Manufacturing Plants	10^6 - 10^8 per minute*
Assembly Facilities	10^5 - 10^6 per minute*
*Number of particles greater than 10 microns ingressed into a system from all sources.	

Filtration Fact

Most system ingression enters a system through the old-style reservoir breather caps and the cylinder rod glands.

Prevention

- Use replaceable element or desiccant style filters for reservoir air breathers.
- Flush all systems before initial start-up.
- Specify rod wipers and replace worn actuator seals.
- Cap off hoses and manifolds during handling and maintenance.
- Filter all new fluid before it enters the reservoir.

Water Contamination

Types

There is more to proper fluid maintenance than just removing particulate matter. Water is virtually a universal contaminant, and just like solid particle contaminants, must be removed from operating fluids. Water can be either in a dissolved state or in a “free” state. Free, or emulsified, water is defined as the water above the saturation point of a specific fluid. At this point, the fluid cannot dissolve or hold any more water. Free water is generally noticeable as a “milky” discoloration of the fluid.

Visual Effects of Water in Oil

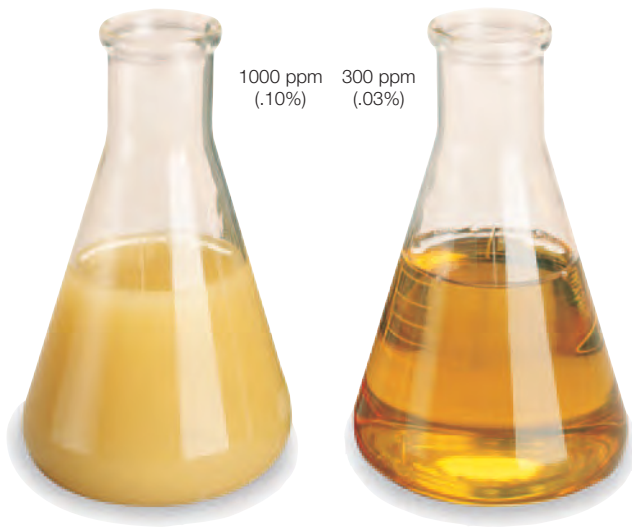

Filtration Fact System Contamination Warning Signals

- Solenoid burn-out.
- Valve spool decentering, leakage, “chattering”.
- Pump failure, loss of flow, frequent replacement.
- Cylinder leakage, scoring.
- Increased servo hysteresis.

Typical Saturation Points

Fluid Type	PPM	%
Hydraulic Fluid	300	.03%
Lubrication Fluid	400	.04%
Transformer Fluid	50	.005%



Contamination Types & Sources

Anti-wear additives break down in the presence of water and form acids. The combination of water, heat and dissimilar metals encourages galvanic action. Pitted and corroded metal surfaces and finishes result. Further complications occur as temperature drops and the fluid has less ability to hold water. As the freezing point is reached, ice crystals form, adversely affecting total system function. Operating functions may also become slowed or erratic.

Electrical conductivity becomes a problem when water contamination weakens the insulating properties of a fluid, this decreases its dielectric kV strength.

Damage



- Corrosion of metal surfaces
- Accelerated abrasive wear
- Bearing fatigue
- Fluid additive breakdown
- Viscosity variance
- Increase in electrical conductivity

Filtration Fact

A simple 'crackle test' will tell you if there is free water in your fluid. Apply a flame under the container. If bubbles rise and 'crackle' from the point of applied heat, free water is present in the fluid.

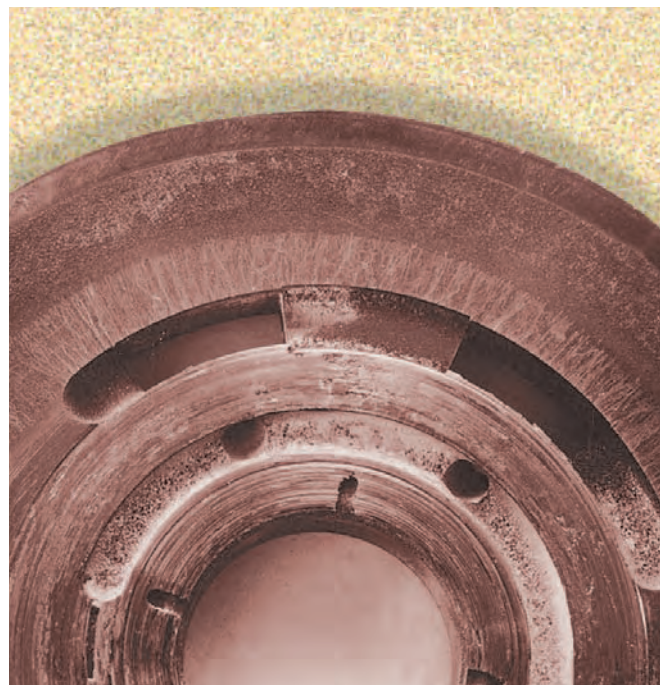

Typical results of pump wear due to particulate and water contamination

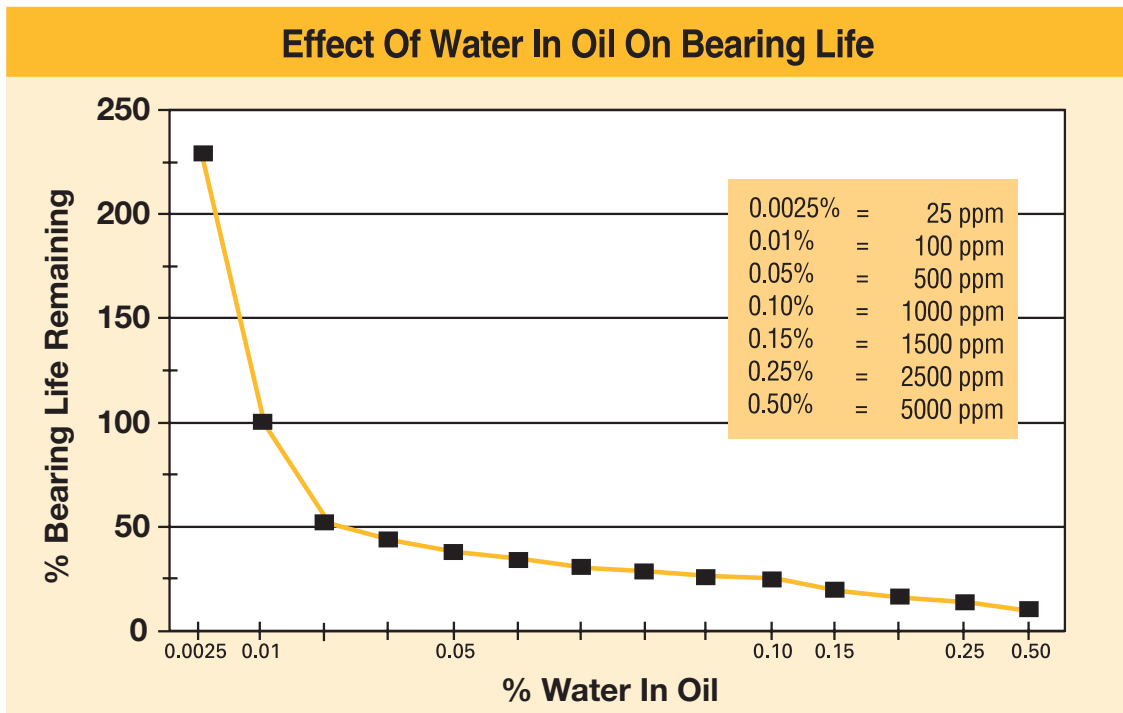

Fluids are constantly exposed to water and water vapour while being handled and stored. For instance, outdoor storage of tanks and drums is common. Water may settle on top of fluid containers and be drawn into the container during temperature changes. Water may also be introduced when opening or filling these containers.

Water can enter a system through worn cylinder or actuator seals or through reservoir openings. Condensation is also a prime water source. As the fluids cool in a reservoir or tank, water vapour will condense on the inside surfaces, causing rust or other corrosion problems.

Sources

- Worn actuator seals
- Reservoir opening leakage
- Condensation
- Heat exchanger leakage

Filtration Fact

Hydraulic fluids have the ability to ‘hold’ more water as temperature increases. A cloudy fluid may become clearer as a system heats up.

Contamination Types & Sources

Prevention

Excessive water can usually be removed from a system. The same preventative measures taken to minimise particulate contamination ingress in a system can be applied to water contamination. However, once excessive water is detected, it can usually be eliminated by one of the following methods:



Absorption

This is accomplished by filter elements that are designed specifically to take out free water. They usually consist of a laminate-type material that transforms free water into a gel that is trapped within the element. These elements fit into standard filter housings and are generally used when small volumes of water are involved.

Centrifugation

Separates water from oil by a spinning motion. This method is really only effective with free water, in larger volumes

Vacuum Dehydration

Separates water from oil through a vacuum and drying process. This method generally associated with for larger volumes of water, but is effective with both the free and dissolved states.



Vacuum Dehydration System

Filtration Fact

Absorption filter elements have optimum performance in low flow and low viscosity applications.

Air Contamination

Types

Air in a liquid system can exist in either a dissolved or entrained (undissolved, or free) state. Dissolved air may not pose a problem, providing it stays in solution. When a liquid contains undissolved air, problems can occur as it passes through system components. There can be pressure changes that compress the air and produce a large amount of heat in small air bubbles. This compressibility of air means that control of the system is lost. The heat can destroy additives, and the base fluid itself.

Damage

If the amount of dissolved air becomes high enough, it will have a negative effect on the amount of work performed by the system. The work performed in a hydraulic system relies on the fluid being relatively incompressible, but air reduces the bulk modulus of the fluid. This is due to the fact that air is up to 20,000 times more compressible than a liquid in which it is dissolved. When air is present, a pump ends up doing more work to compress the air, and less useful work on the system. In this situation, the system is said to be 'spongy'.

- Loss of transmitted power
- Reduced pump output
- Loss of lubrication
- Increased operating temperature
- Reservoir fluid foaming
- Chemical reactions

Air in any form is a potential source of oxidation in liquids. This accelerates corrosion of metal parts, particularly when water is also present. Oxidation of additives also may occur. Both processes produce oxides which promote the formation of particulates, or form a sludge in the liquid. Wear and interference increases if oxidation debris is not prevented or removed.

Filtration Fact

Free water is heavier than oil, thus it will settle to the bottom of the reservoir where much of it can be easily removed by opening the drain valve.

Sources

- System Leaks
- Pump aeration
- Reservoir fluid turbulence

Prevention

- System air bleeds
- Flooded suction pump
- Proper reservoir design
- Return Line Diffusers

Fluid Cleanliness Standards

In order to detect or correct problems, a contamination reference scale is used. Particle counting is the most common method used to derive cleanliness level standards. Very sensitive optical instruments are used to count the number of particles in various size ranges. These counts are reported as the number of particles greater than a certain size found in a specified volume of fluid.

The new ISO 11171 (International Standards Organization) Cleanliness Level Standard replaced ISO 4406 upon acceptance of ISO MTD (Medium Test Dust) as a replacement for ACFTD. The most widely-used version of this standard references the number of particles greater than 4, 6, and 14 micrometres in 1 millilitre of fluid. The number of 4+ and 6+ micrometre particles is used as a reference point for “silt” particles. The 14+ size range indicates the quantity of larger particles present which contribute greatly to possible catastrophic component failure.

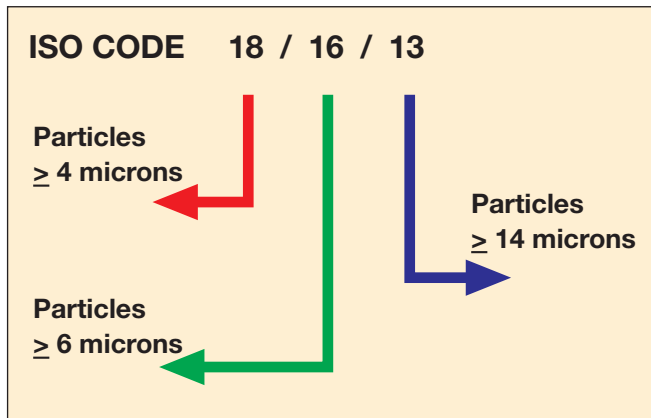

ISO Classification & Definition		
Range number	Micron	Actual Particle Count Range (per ml)
18	4+	1,300 - 2,500
16	6+	320 - 640
13	14+	40 - 80

The ISO codes 4, 6, 14 microns replace the 2 digit 5, 15 microns and 3 digit 2, 5, 15 microns in use prior to the introduction of ISO MTD. Their use continues and the results remain comparable with the 4, 6, 14 micron ISO codes.

Particle Counts Comparison Table

Table G.2 – Correlation between particle sizes obtained using;

ACFTD (ISO 4402:1991) & NIST (ISO 11171) calibration methods

Particle size obtained using;	
ACFTD size (ISO 4402:1991) µm	NIST (ISO 11171) size µm[c]
1	4.2
2	4.6
3	5.1
4	5.8
5	6.4
6	7.1
7	7.7
8	8.4
9	9.1
10	9.8
11	10.6
12	11.3
13	12.1
14	12.9
15	13.6
16	14.4
17	15.2
18	15.9
19	16.7
20	17.5
21	18.2
22	19.0
23	19.7
24	20.5
25	21.2
26	22.0
27	22.7
28	23.5
29	24.2
30	24.9
31	25.7
32	26.4
33	27.1
34	27.9
35	28.5
36	29.2
37	29.9
38	30.5
39	31.1
40	31.7

Note; This table is only a guideline. The exact relationship between ACFTD sizes and the NIST sizes may vary from instrument to instrument, depending on the characteristics of the particle counter and the original ACFTD calibration. ISO 1999. All rights reserved.

ISO 4406:1999 Chart

Range number	Number of particles per ml	
	More than	Up to and including
24	80,000	160,000
23	40,000	80,000
22	20,000	40,000
21	10,000	20,000
20	5,000	10,000
19	2,500	5,000
18	1,300	2,500
17	640	1,300
16	320	640
15	160	320
14	80	160
13	40	80
12	20	40
11	10	20
10	5	10
9	2.5	5
8	1.3	2.5
7	.64	1.3
6	.32	.64

Filtration Fact

Knowing the cleanliness level of a fluid is the basis for contamination control measures.

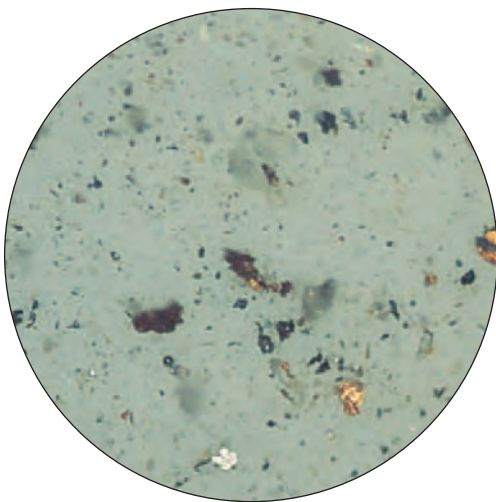

ISO 21 / 19 / 17 fluid (magnification 100x)

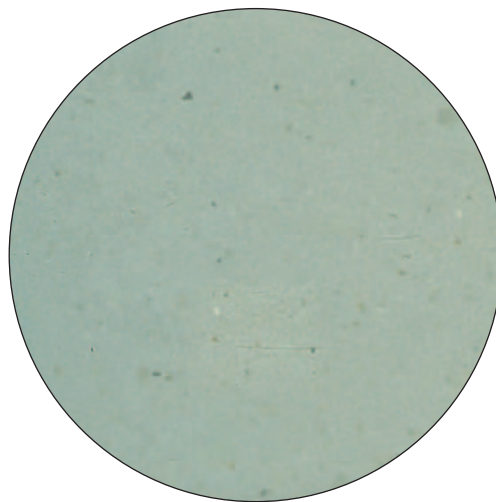

ISO 16 / 14 / 11 fluid (magnification 100x)

Fluid Cleanliness Standards

Component Cleanliness Level Requirements

Many manufacturers of hydraulic and load bearing equipment specify the optimum cleanliness level required for their components. Subjecting components to fluid with higher contamination levels may result in much shorter component life.

In the table opposite, a few components and their recommended cleanliness levels are shown. It is always best to consult with component manufacturers and obtain their written fluid cleanliness level recommendations. This information is needed in order to select the correct level of filtration.

It may also prove useful for any subsequent warranty claims, as it may draw the line between normal use and excessive or abusive operation.

Fluid Cleanliness Required for Typical Hydraulic Components

Components	ISO Code
Servo control valves	16 / 14 / 11
Proportional valves	17 / 15 / 12
Valve & piston pumps / motors	18 / 16 / 13
Directional & pressure control valves	18 / 16 / 13
Gear pumps / motors	19 / 17 / 14
Flow control valves, cylinders	20 / 18 / 15
New unused fluid	20 / 18 / 15



Filtration Fact

Most machine and hydraulic component manufacturers specify a target ISO cleanliness level to equipment in order to achieve optimal performance standards.

Size Range (Microns)	NAS 1638 CLEANLINESS CLASSIFICATION CODES (per ml.)													
	00	0	1	2	3	4	5	6	7	8	9	10	11	12
2 to 5	7.75	15.50	31	62	124	248	496	992	1984	3968	7936	15872	32302	63488
5 to 15	1.25	2.50	5	10	20	40	80	160	320	640	1280	2560	5120	10240
15 to 25	0.22	0.44	0.89	1.78	3.56	7.12	14.25	28.50	57	114	228	456	912	1824
25 to 50	0.04	0.08	0.16	0.32	0.63	1.26	2.53	5.06	10.12	20.25	40.50	81	162	324
50 to 100	0.01	0.02	0.03	0.06	0.11	0.22	0.45	0.90	1.80	3.60	7.20	14.40	28.80	57.60
>100	0.00	0.00	0.01	0.01	0.02	0.04	0.08	0.16	0.32	0.64	1.28	2.56	5.12	10.24

Cleanliness Level Correlation Table						
Code to ISO4406: 1999	Particles per Millilitre (ISO11171 μm [c])			NAS 1638 (1964)	Disavowed SAE level (1963)	SAE AS 4059
	>4 Microns	>6 Microns	>14 Microns			
23/21/18	80,000	20,000	2,500	12		-
22/20/17	40,000	10,000	1,300	11		A12 / B12 / C11
21/19/16	20,000	5,000	640	10		A11 / B11 / C10
20/18/15	10,000	2,500	320	9	6	A10 / B10 / C9
19/17/14	5,000	1,300	160	8	5	A9 / B9 / C8
18/16/13	2,500	640	80	7	4	A8 / B8 / C7
17/15/12	1,300	320	40	6	3	A7 / B7 / C6
16/14/11	640	160	20	5	2	A6 / B6 / C5
15/13/10	320	80	10	4	1	A5 / B5 / C4
14/12/09	160	40	5	3	0	A4 / B4 / C3
13/11/08	80	20	2.50	2		A3 / B3 / C2
12/10/07	40	10	1.30	1		A2 / B2 / C1
11/09/06	20	5	0.64	0		A1 / B1 / C0
10/08/05	10	2.50	0.32	00		A0 / B0 / C000

Note

Due to the differences in the way in which each of these methods are designed, it is not possible to offer a precise, direct comparison. The correlation table above offers comparisons that are accurate within accepted limits

Filtration Fact

Colour is not a good indicator of a fluid's cleanliness level.

Filter Media Types & Ratings

The filter media is that part of the element which removes the contaminant.

Media usually starts out in sheet form, and is then pleated to expose more surface area to the fluid flow. This reduces pressure differential while increasing dirt holding capacity. In some cases, the filter media may have multiple layers and mesh backing to achieve certain performance criteria. After being pleated and cut to the proper length, the two ends are fastened together using a special clip, adhesive, or other seaming mechanism. The most common media include wire mesh, cellulose, fibreglass composites, or other synthetic materials. Filter media is generally classified as either **surface or depth**.

Surface Media



For surface type filter media, the fluid stream basically has a straight through flow path. Contaminant is captured on the surface of the element which faces the fluid flow. Surface type elements are generally made from woven wire.

Since the process used in manufacturing the wire cloth can be very accurately controlled, surface type media have a consistent pore size. This consistent pore size is the diameter of the largest hard spherical particle that will pass through the media under specified test conditions. However, the build-up of contaminant on the element surface will allow the media to capture particles smaller than the pore size rating. Likewise, particles that have a smaller diameter, but may be longer in length (such as a fibre strand), may pass downstream of a surface media.

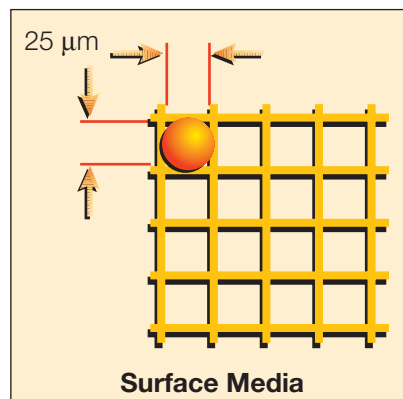

Filtration Fact

Surface media can be cleaned and re-used. An ultrasonic cleaner is usually the best method. Depth media typically cannot be cleaned and it is not re-usable.

Depth Media

For depth type filter media, fluid must take indirect paths through the material which makes up the filter media. Particles are trapped in the maze of openings throughout the media. Because of its construction, a depth type filter media has many pores of various sizes. Depending on the distribution of pore sizes, this media can have a very high capture rate at very small particle sizes.

The nature of filtration media and the contaminant loading process in a filter element explains why some elements last much longer than others. In general, filter media contain millions of tiny pores formed by the media fibres. The pores have a range of different sizes and are interconnected

throughout the layer of the media to form a tortuous path for fluid flow.

The two basic depth media types which are used for filter elements are cellulose and fibreglass.

The pores in cellulose media tend to have a broad range of sizes due to the irregular size and shape of the fibres. This results in variable particle removal. Due to this unreliable performance cellulose is no longer popular with companies requiring reliable, predictable performance. In contrast, fibreglass media consist of fibres which are very uniform in size and shape. The fibres are generally thinner than cellulose fibres, and have a uniform circular cross section. These

typical fibre differences account for the performance advantage of fibreglass media. Thinner fibres mean more actual pores in a given space. Furthermore, thinner fibres can be arranged closer together to produce smaller pores for finer filtration. Dirt holding capacity, as well as filtration efficiency, are improved as a result.

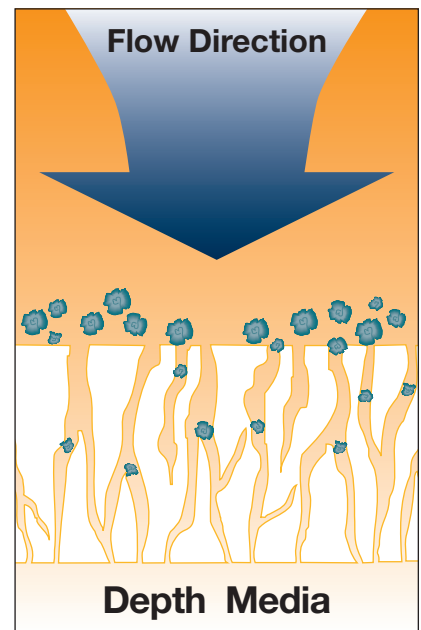

General Comparison of Filter Media

Media Material	Capture Efficiency	Dirt Holding Capacity	Differential Pressure	Life in a System	Overall Through Life Cost
Wire Mesh	Low	Low	Low	Moderate to High	Moderate
Cellulose	Moderate	Moderate	High	Moderate	Moderate to High
Fibreglass	High	High	Moderate to High	High	Moderate
Graded Layer Fibreglass	High	Very High	Moderate to High	Very High	Moderate to Low

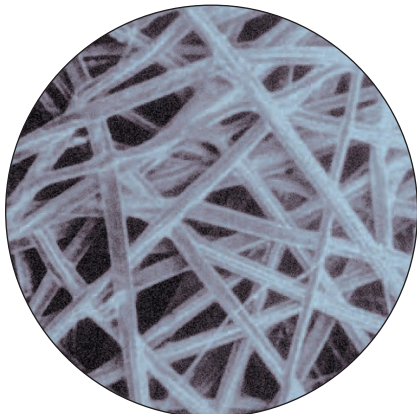

Typical course fibreglass construction (100x)

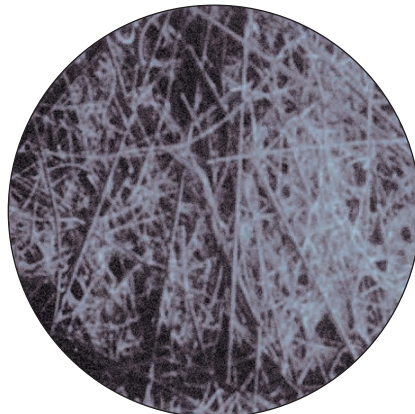

Typical fine fibreglass construction (100x)

Filter Media Types & Ratings

The Multipass Test

The filtration industry uses the ISO 16889 “Multipass Test Procedure” to evaluate filter element performance. During the Multipass Test, fluid is circulated through the circuit under precisely controlled and monitored conditions. The differential pressure across the test element is continuously recorded, as a constant amount of contaminant is injected upstream of the element.

Online laser particle sensors determine the contaminant levels upstream and downstream of the test element. This performance attribute (The Beta Ratio) is determined for several particle sizes.

Three important element performance characteristics are a result of the Multipass Test:

1. Dirt holding capacity.
2. Pressure differential of the test filter element.
3. Separation or filtration efficiency, expressed as a “Beta Ratio”

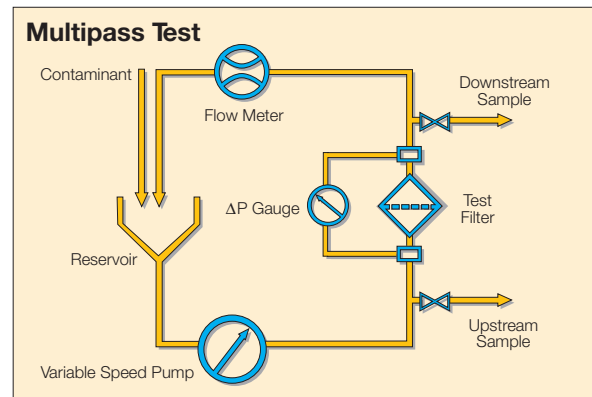

Beta Ratio



Filtration Fact

Filter media ratings expressed as a Beta Ratio indicate a media’s particle removal efficiency.

The Beta Ratio (also known as the filtration ratio) is a measure of the particle capture efficiency of a filter element. It is therefore a performance rating.

As an example of how a Beta Ratio is derived from a Multipass Test. Assume that 50,000 particles, 10 micrometres and larger, were counted upstream (before) of the test filter and 25 particles at that same size range were counted downstream (after) of the test filter. The corresponding Beta Ratio would equal 200, as seen in example 1.

The example would read “Beta ten equal to 200.” Now, a Beta Ratio number alone means very little. It is a preliminary step to find a filter’s particle capture efficiency. This efficiency, expressed as a percent, can be found by a simple equation. (Example 2)

$$\text{Efficiency}_x = \left(1 - \frac{1}{\beta}\right) 100$$

$$\begin{aligned} \text{Efficiency}_{10} &= \left(1 - \frac{1}{200}\right) 100 \\ &= 99.5\% \end{aligned}$$

Example 1

$$\beta_x = \frac{\text{\# of particles upstream}}{\text{\# of particles downstream}}$$

“X” is at a specific particle size

$$\beta_{10}(c) = \frac{50,000}{25} = 200$$

Example 2

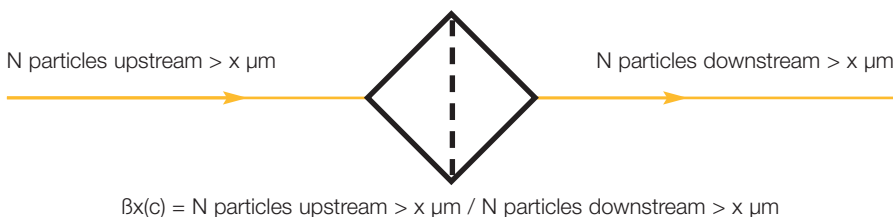

Beta Ratios / Efficiencies

Beta Ratio (at a given particle size)	Capture Efficiency (at same particle size)
1.01	1.0%
1.1	9.0%
1.5	33.3%
2.0	50.0%
5.0	80.0%
10.0	90.0%
20.0	95.0%
75.0	98.7%
100	99.0%
200	99.5%
1000	99.9%

So, in the example, the particular filter tested was 99.5% efficient at removing 10 micrometre and larger particles. The Beta Ratio/ Efficiencies table shows the general range Beta Ratio numbers and their corresponding efficiencies.

Filtration Fact

Multipass test results are very dependent on the following variables:

- Flow rate
- Terminal differential pressure

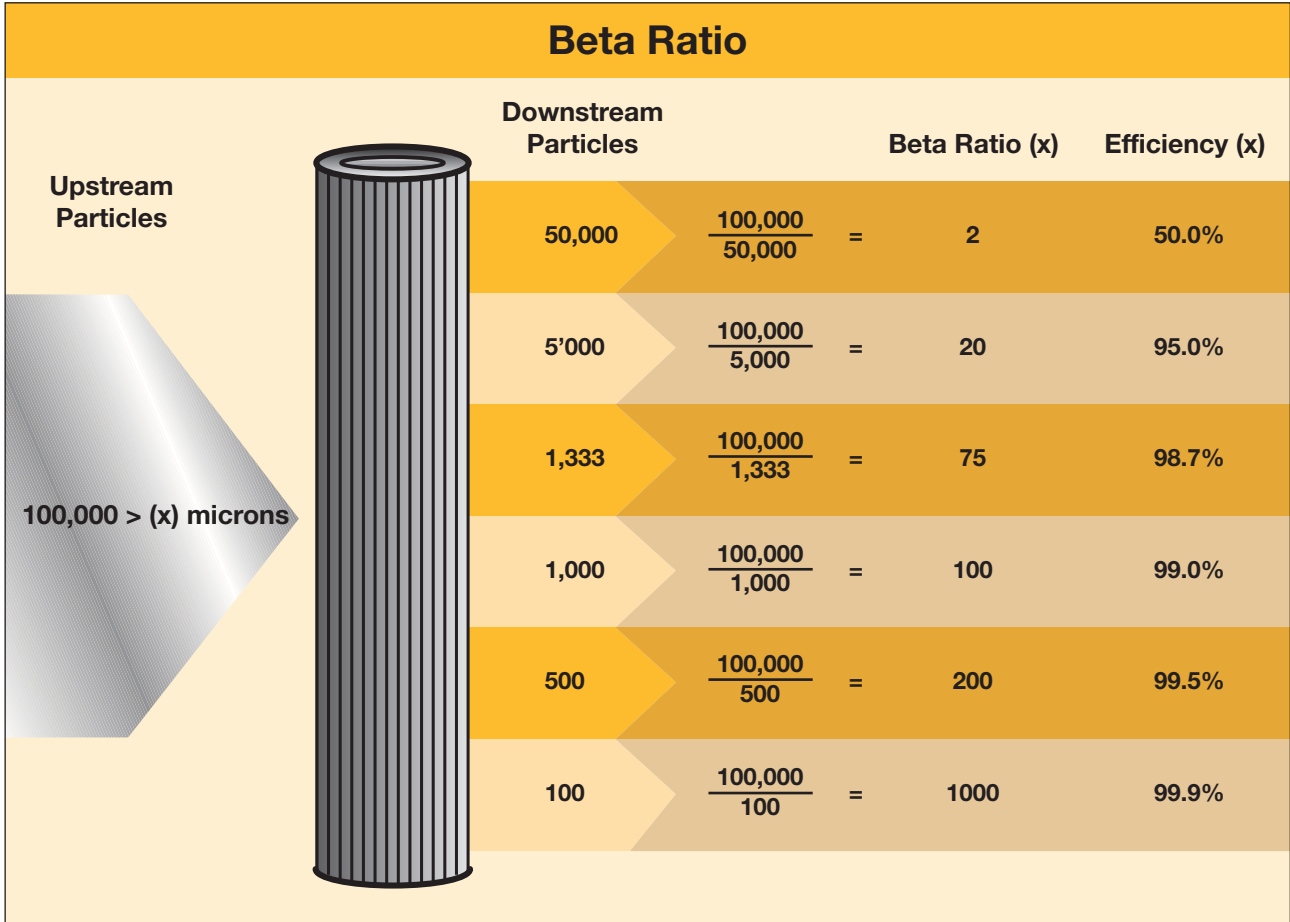

Filter Media Selection

Instructions

From the following seven (7) system parameter tables, select the weighting factor which applies to your application. Add these weighting factors together and consult the 'Total Weighting Graph' (Figure 1). The total weighting factor is found on the vertical axis. Draw a straight line from left to right, starting at the total weighting factor number. This line is parallel to the horizontal axis. The total weighting line will intersect the media rating range band (found in the graph) at two points.

Next, draw a line from the two intersection points down to the horizontal axis. This axis shows the particle sizes where the media should have a Beta rating of at least 200 (99.5% separation efficiency). This indicates the most suitable range of media ratings for your application. Consult the individual product catalogue(s) to match this result to a specific media.

Table A
Pressure & Duty Cycles

(To take account of the Normal operating pressure & it's severity of change, both in magnitude & frequency)

Pressure; Select operating pressure

Duty;

LIGHT Continuous operation at rated pressure or lower

MEDIUM Medium pressure changes up to rated pressure

HEAVY Zero to full pressure

SEVERE Zero to full pressure - with transients at high frequency (0.6Hz) (e.g. power unit supplying a punching machine)

Select weighting from table below;

Pressure		Duty			
PSI	Bar	Lt	Med	Hvy	Sev
0-1015	0-70	1	2	3	4
1015-2175	70-150	1	3	4	5
2175-3625	150-250	2	3	4	6
3625-5075	250-350	3	5	6	7
5075+	350+	4	6	7	8

Weighting No.

Table B
Environment

	Examples	Weighting
Good	Clean area's, Lab's	0
Average	General machine shops assembly plants	1
Poor	Mobile mills (metal & paper)	2
Hostile	Foundries, also where ingression of contaminant is expected to be very high	3

Weighting No.

Table C
Component Sensitivity

	Examples	Weighting
Very High	High performance servo valves	8
High	Industrial servo valves	6
Above average	Piston pumps, proportional valves, compensated flow controls	4
Average	Vane pumps, spool valves	3
Below average	Gear pumps, manual & poppet valves	2
Minimal	Ram pumps & cylinders	1

Weighting No.

Table D
Life Expectancy

Hours	Weighting
0-1,000	0
1,000-5,000	1
5,000-10,000	2
10,000-20,000	3
20,000+	5

Weighting No.

Table E
Component Economic Liability

To account for the cost of component replacement

	Examples	Weighting
Very High	Large piston pumps, large high torque low speed motors	4
High	Cylinders, servo valves, piston motors	3
Average	Line mounted valves	2
Low	Subplate mounted valves, inexpensive gear pumps	1

Weighting No.

Table F
Operational Economic Liability

To account for the cost of downtime

	Examples	Weighting
Very High	Very expensive downtime of certain paper, steel mill equipment & automotive equipment	5
High	High volume production equipment	3
Average	Critical, but non-production equipment	2
Low	Equipment not critical to production	1

Weighting No..

Table G
Operation Economic Liability

To account for the cost of downtime

	Examples	Weighting
High	Mine winding gear breaking systems	3
Average	Where failure is likely to cause a hazard	1
Low	Some hydraulic component test stands; negligible hazard	0

Weighting No.

Total Weighting of all Tables

Selecting the Correct Media

A number of interrelated system factors determines the most suitable filter media for a particular application. The following media selection method was developed by the British Fluid Power Association (B.F.P.A.) and is used with permission. This media selection process uses a 'weighting' system based upon the relative importance of major systems factors. Simply add the individual 'weighting' factors from the seven (7) system parameter tables on the previous page. Then, consult the 'Total Weighting Graph' (Figure 1) to find the appropriate rating range of suitable media. This rating range is based upon 'absolute' media ratings, where the Beta rating is equal to or greater than 200 (99.5% separation efficiency).

It must be emphasized that the rating range obtained can only be considered as an approximation. Precise operating parameters are often difficult to quantify by both users and makers of filtration equipment. Once the approximate rating range has been established, the final media selection should be based on the specific characteristics of a given medium. For more information about specific media performance, the appropriate product catalogue's should be consulted.

Figure 1

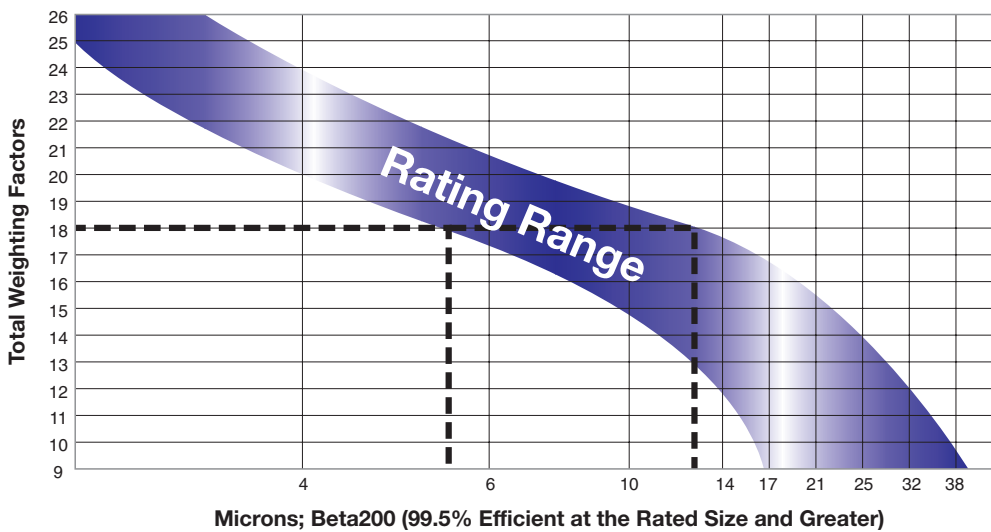

Example

Consider a large hydraulic excavator operating in a quarry. The hydraulic includes spare pressure compensated piston pumps and very large lift cylinders.

Operating Pressure & Duty Cycle (Table A)

The system operates at 245 bar with extremes of both flow and pressure fluctuations in a cycle that is repeated approximately four times every minute. For this reason it is considered to be

Heavy Weighting = 4

Environment (Table B)

The environment in which this machine is working can, in dry weather, be very dirty. As a result, ingress is likely to be high.

Poor Weighting = 2

Component Sensitivity (Table C)

Although the majority of the components are considered to be of average sensitivity, the pumps are;

Above Average Weighting = 4

Life Expectancy (Table D)

The annual usage is about 2000 hours & component life is expected to be about 4 years hence 8000 hours and a weighting of;

5,000-10,000 Hours Weighting = 2

Economic Liabilities (Components) (Table E)

Components such as lift cylinders & variable piston pumps are quite expensive for the end user to purchase.

Component costs are high, hence;

High Weighting = 3

Economic liabilities (Operational) (Table F)

Economic liabilities caused by downtime vary depending upon the specific quarry situation, but the high capital cost of the system puts it in HIGH category.

High Weighting = 3

Safety Liabilities (Table G)

No additional weighting to take account of safety is required

Low Weighting = 0

Total Weighting

(Sum of individual Weightings) = 18

The weighting selected is in the range of 4 to 13 microns. The media selected should have a minimum Beta Ratio Beta13 = 200 (99.5% efficient)

Filtration Fact

There is no direct correlation between using a specific media and attaining a specific ISO cleanliness classification. Numerous other variables should be considered, such as particulate ingress, actual flow through filters, and filter locations.

Filter Element Life

Contaminant Loading

Contaminant loading in a filter element is simply the process of blocking the pores throughout the element. As the filter element becomes blocked with contaminant particles, there are fewer pores for fluid flow, and the pressure required to maintain flow through the media increases. Initially, the differential pressure across the element increases very slowly because there is an abundance of media pores for the fluid to pass through, and the pore blocking process has little effect on the overall pressure loss. However, a point is reached at which successive blocking of media pores significantly reduces the number of available pores for flow through the element.

At this point the differential pressure across the element rises exponentially. The quantity, size, shape and arrangement of the pores throughout the element accounts for why some elements last longer than others.

For a given filter media thickness and filtration rating, there are fewer pores with cellulose media than fibreglass media. Accordingly, the contaminant loading process would block the pores of the cellulose media element quicker than the identical fibreglass media element.

The multilayer fibreglass media element is relatively unaffected by contaminant loading for a longer time. The element selectively captures the various size particles, as the fluid passes through the element. The very small pores in the media are not blocked by large particles. These downstream small pores remain available for the large quantity of very small particles present in the fluid.

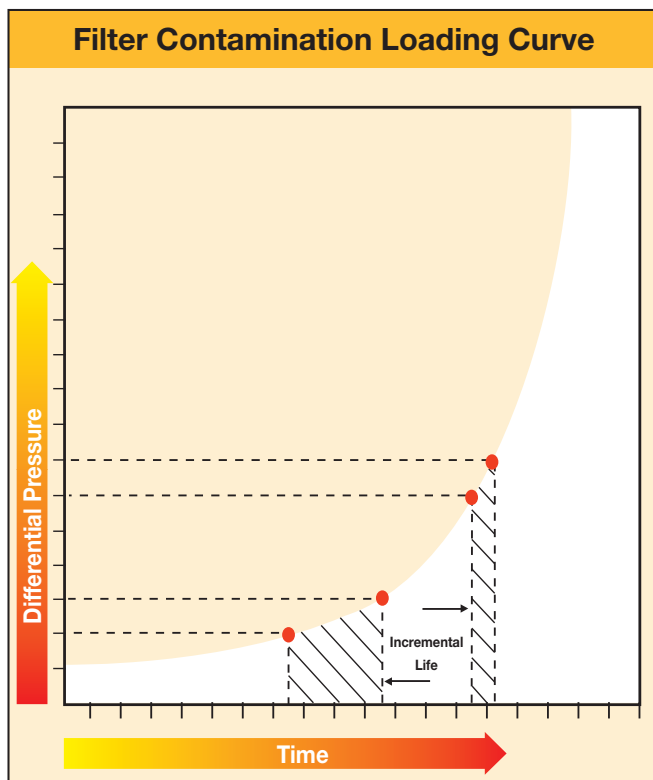

Filtration Fact

As an element loads with contamination, the differential pressure will increase over time; slowly at first, then very quickly as the element nears its maximum life.

Filter Element Life Profile

Every filter element has a characteristic pressure differential versus contaminant loading relationship. This relationship can be defined as the “filter element life profile.” The actual life profile is obviously affected by the system operating conditions. Variations in the system flow rate and fluid viscosity affect the clean pressure differential across the filter element and have a well-defined effect upon the actual element life profile.

The filter element life profile is very difficult to evaluate in actual operating systems. The system operating versus idle time, the duty cycle and the changing ambient contaminant conditions all affect the life profile of the filter element. In addition, precise instrumentation for recording the change in the pressure loss across the filter element is seldom available. Most machinery users and designers simply specify filter housings with differential pressure indicators to signal when the filter element should be changed.

The Multipass Test data can be used to develop the pressure differential versus contaminant loading relationship, defined as the filter element life profile. As previously mentioned, such operating conditions as flow rate and fluid viscosity affect the life profile for a filter element.

Life profile comparisons can only be made when these operating conditions are identical and the filter elements are the same size.

Then, the quantity, size, shape, and arrangement of the pores in the filter element determine the characteristic life profile. Filter elements that are manufactured from cellulose media, single layer fibreglass media and multilayer fibreglass media all have a very different life profile. The graphic comparison of the three most common media configurations clearly shows the life advantage of the multilayer fibreglass media element.

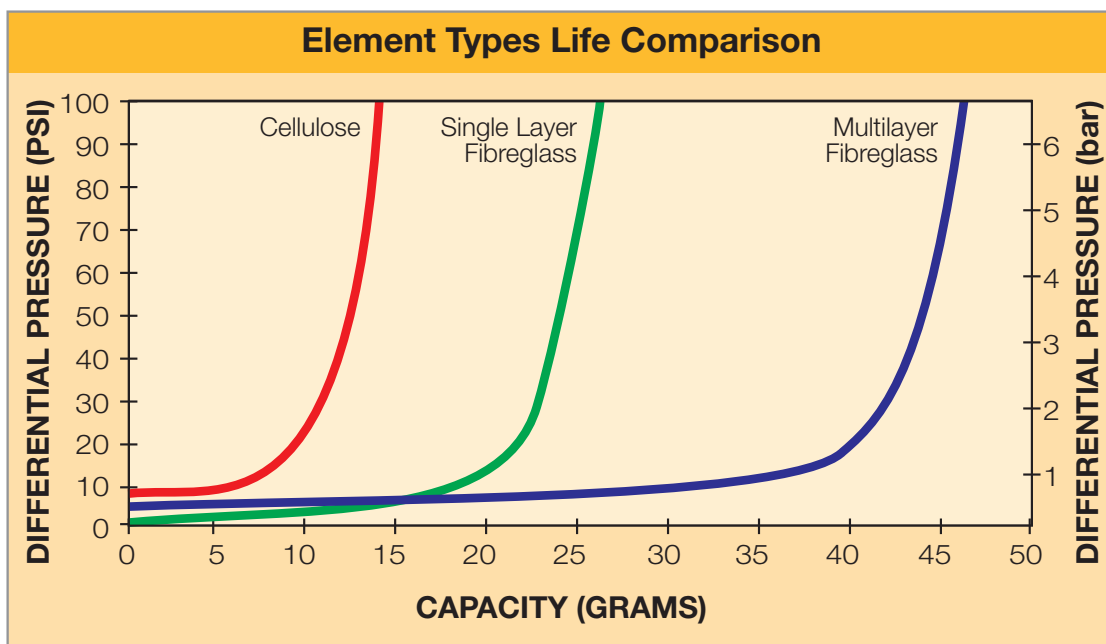

Filter Housing Selection

Filter Housings

The filter housing is the pressure vessel which contains the filter element. It usually consists of two or more sub-assemblies, such as a head (or cover) and a bowl to allow access to the filter element. The housing has inlet and outlet ports allowing it to be installed into a fluid system. Additional housing features may include mounting holes, bypass valves and element condition indicators.

The primary concerns in the housing selection process include mounting methods, porting options, indicator options, and pressure rating. All, except the pressure rating, depend on the physical system design and the preferences of the designer. Pressure rating of the housing is far less arbitrary. This should be determined before the housing style is selected.

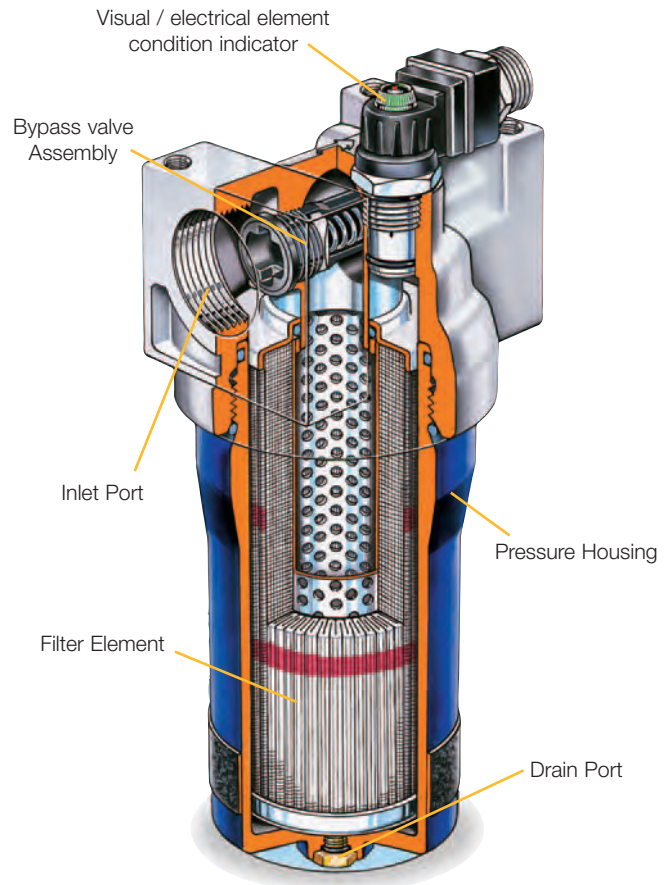

Pressure Ratings

Filtration Fact

Always use an element condition indicator with any filter, especially those that do not have a bypass valve.

Location of the filter in the circuit is the primary determinant of pressure rating. Filter housings are generically designed for three locations in a circuit: suction, pressure, or return lines. One characteristic of these locations is their maximum operating pressures. Suction and return line filters are generally designed for lower pressures up to 34 bar. Pressure filter locations may require ratings from 100 bar to 420 bar. It is essential to analyse the circuit for frequent pressure

spikes as well as steady state conditions. Some housings have restrictive or lower fatigue pressure ratings. In circuits with frequent high pressure spikes, another type housing may be required to prevent fatigue related failures.

The Bypass Valve

The bypass valve is used to prevent the collapse or burst of the filter element when it becomes highly loaded with contaminant. It also prevents pump cavitation in the case of suction line filtration. As contaminant builds up in the element, the differential pressure across the element increases. At a pressure well below the failure point of the filter element, the bypass valve opens, allowing flow to go around the element.

Some bypass valve designs have a “bypass to-tank” option. This allows the unfiltered bypass flow to return to tank through a third port, preventing unfiltered bypass flow from entering the system. Other filters may be supplied with a “no bypass” or “blocked” bypass option. This prevents any unfiltered flow from going downstream. In filters with no bypass valves, higher collapse strength elements are strongly recommended, especially in high pressure filters. Applications for using a “no bypass” option include servo valve and other sensitive component protection. When specifying a non-bypass filter design, make sure that the element has a differential pressure rating close to maximum operating pressure of the system. When specifying a bypass type filter, it can generally be assumed that the manufacturer has designed the element to withstand the bypass valve differential pressure when the bypass valve opens.

After a housing style and pressure rating are selected, the bypass valve setting needs to be chosen. The bypass valve setting must be selected before sizing a filter housing. Everything else being equal, the highest bypass cracking pressure available from the manufacturer should be selected. This will provide the longest element life for a given filter size.

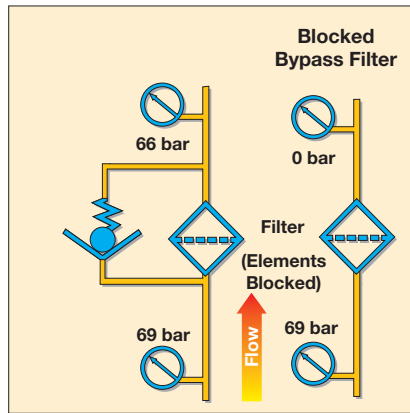

Occasionally, a lower setting may be selected to help minimize energy loss in a system, or to reduce back-pressure on another component. In suction filters, either a 0.14 bar or 0.2 bar bypass valve is used to minimise the chance of potential pump cavitation.

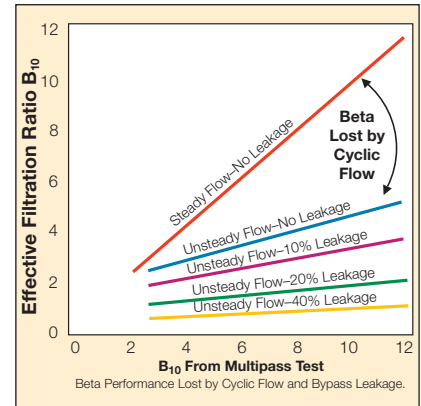

Filtration Fact

An element loading with contaminant will continue to increase in pressure differential until either:

- The element is replaced.
- The bypass valve opens.
- The element fails.

Filter Housing Selection

Element Condition Indicators

The element condition indicator signals when the element should be cleaned or replaced. The indicator often has calibration marks which also indicates if the filter bypass valve has opened. The indicator may be mechanically linked to the bypass valve, or it may be an entirely independent differential pressure sensing device. Indicators may give visual, electrical or both types of signals. Generally, indicators are set to trip anywhere from 5%-25% before the bypass valve opens.



Filtration Fact

Always consider low temperature conditions when sizing filters. Viscosity increases in the fluid may cause a considerable increase in pressure differential through the filter assembly.

Housings And Element Sizing

The filter housing size should be large enough to achieve at least a 3:1 ratio between the bypass valve setting and the pressure differential of the filter with a clean element installed.

For example, the graph on the next page illustrates the type of catalogue flow/pressure differential curves which are used to size the filter housing. As can be seen, the specifier needs to know the operating viscosity of the fluid, and the maximum flow rate (instead of an average) to make sure that the filter does not spend a high portion of time in bypass due to flow surges. This is particularly important in return line filters, where flow multiplication from cylinders may increase the return flow compared to the pump flow rate.

If the filter described in the graph was fitted with a 3.5 bar bypass valve the initial (clean) pressure differential should be no greater than 1.1 bar. This is calculated from the 3:1 ratio of bypass setting and initial pressure differential.

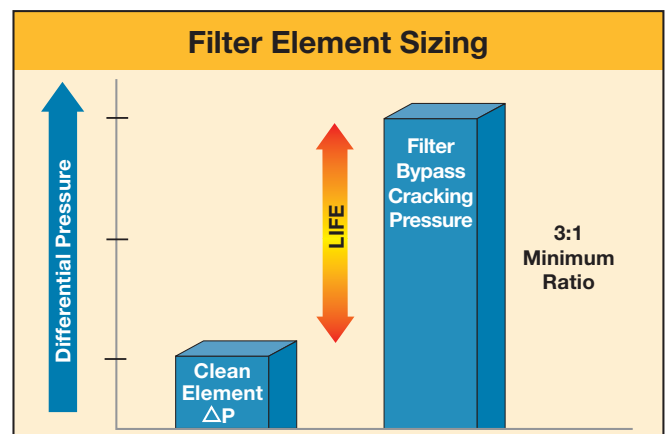

Typical Flow / Pressure Curves For a Specific Media

28P-2 High Collapse Elements Only

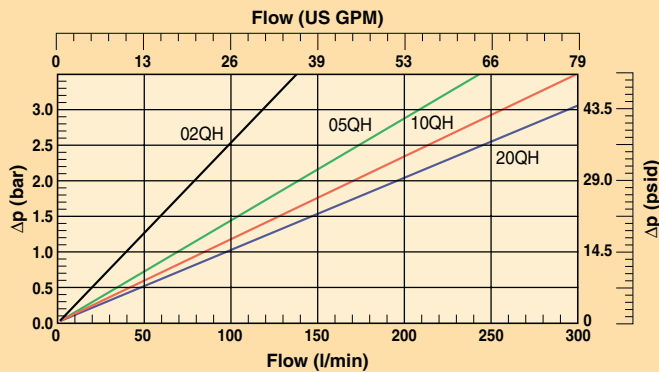

Most standard filter assemblies utilize a bypass valve to limit the maximum pressure drop across the filter element. As the filter element becomes blocked with contaminant, the pressure differential increases until the bypass valve cracking pressure is reached. At this point, the flow through the filter assembly begins bypassing the filter element and partly flows through the bypass valve. This action limits the maximum pressure differential across the filter element. The important issue is that some of the contaminant particles within the system fluid also bypass the filter element. When this happens, the effectiveness of the filter element is compromised and the attainable system fluid cleanliness degrades. Standard filter assemblies normally have a bypass valve cracking pressure set at between 0.8 and 7 bar.

The relationship between the starting clean pressure differential across the filter

element and the bypass valve pressure setting must be considered. A cellulose element has a narrow region of exponential pressure rise.

For this reason, the relationship between the starting clean pressure differential and the bypass valve pressure setting is very important. This relationship in effect determines the useful life of the filter element.

In contrast, the useful element life of the single layer and multilayer fibreglass elements is established by the nearly horizontal, linear region of relatively low pressure drop increase, not the region of exponential pressure rise. Accordingly, the filter assembly bypass valve cracking pressure, whether 0.8 or 7 bar, has relatively little impact on the useful life of the filter element. Thus, the initial pressure differential and bypass valve setting is less of a sizing factor when fibreglass media is being considered.

Filtration Fact

Pressure differential in a filter assembly depends on:

1. Housing and element size
2. Media grade
3. Fluid viscosity
4. Flow rate
5. Fluid Density

Types & Locations of Filters

Filter Types & Locations

- Air Filter
- Suction
- Pressure
- Return
- Off-line

Air Filter

The forgotten system filter, the air filter is an important, integral part of the contamination control package. Any breathing system (one which allows air to be drawn into and expelled from, the fluid reservoir during system operation) will require an air filter. A good quality air filter, sized to meet the needs of the system components, will be an effective barrier against the ingress of contaminants. Effective contamination control can be attained by just removing the contaminants that enter the fluid system, however, how much more effective would the system filters be, if the contaminants being ingested by a breathing system were prevented from entering the system? Why allow contaminants to enter the system and then spend time & money trying to remove them? Fit a fine, high capacity EAB or ABL environmentally friendly air filter and prevent the initial ingress, this way, the system filters can be taking out contaminants generated from within the system itself.

Suction Filters

Suction filters serve to protect the pump from fluid contamination. They are located before the inlet port of the pump. Some may be inlet “strainers”, submersed in the fluid. Others may be externally mounted. In either case, they utilise relatively coarse elements, due to cavitation limitations of pumps. For this reason, they are not used as primary protection against contamination. Some pump manufactures do not recommend the use of a suction filter. Always consult the pump manufacturer for inlet restrictions.

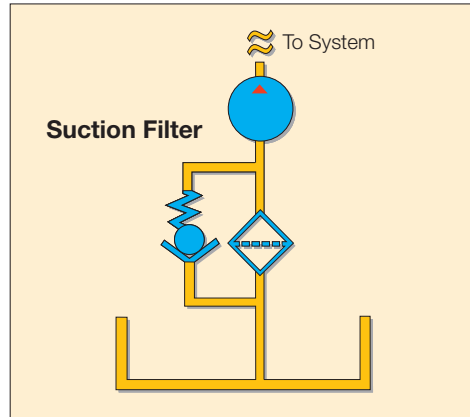

Filtration Fact

Suction strainers are often referred to by “mesh” size:

60 mesh	=	238 micron
100 mesh	=	149 micron
200 mesh	=	74 micron

Pressure Filters

Pressure filters are located downstream from the system pump. They are designed to handle the system pressure and sized for the specific flow rate in the pressure line where they are located.

Pressure filters are especially suited for protecting sensitive components directly downstream from the filter, such as servo valves. Located just downstream from the system pump, they also help protect the entire system from pump generated contamination.

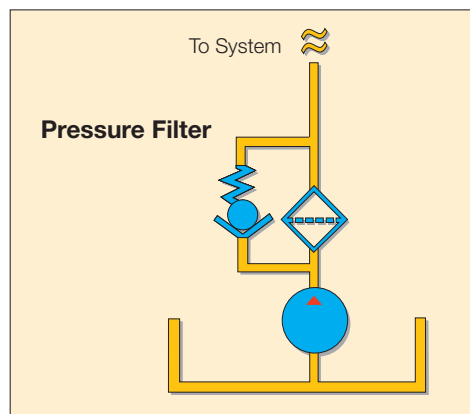

Return Filters

When the pump is the most sensitive component in a system, a return filter may be the best choice. In most systems, the return filter is the last component through which fluid passes before entering the reservoir. Therefore, it captures wear debris from system working components and particles entering through worn cylinder rod seals before such contaminant can enter the reservoir and be circulated. Since this filter is located immediately upstream from the reservoir, its pressure rating and cost can be relatively low.

In some cases, cylinders with large diameter rods may result in “flow multiplication”. The increased return line flow rate may cause the filter bypass valve to open, allowing unfiltered flow to pass downstream. This may be an undesirable condition and care should be taken in sizing the filter.

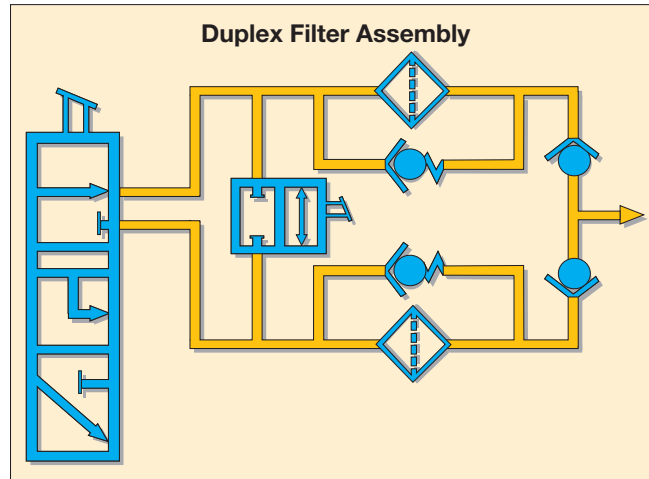

Both pressure and return filters can commonly be found in a duplex version. Its most notable characteristic is continuous filtration. That is, it is made with two or more filter chambers and includes the necessary valving to allow for continuous, uninterrupted filtration. When a filter element needs servicing, the duplex valve is shifted, diverting flow to the opposite

filter chamber. The dirty element can then be changed, while filtered flow continues to pass through the filter assembly. The duplex valve typically is an open cross-over type, which prevents any flow blockage.

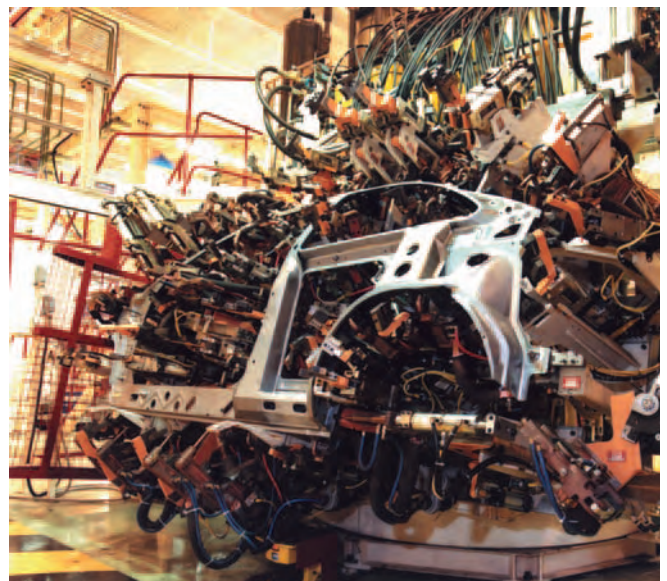
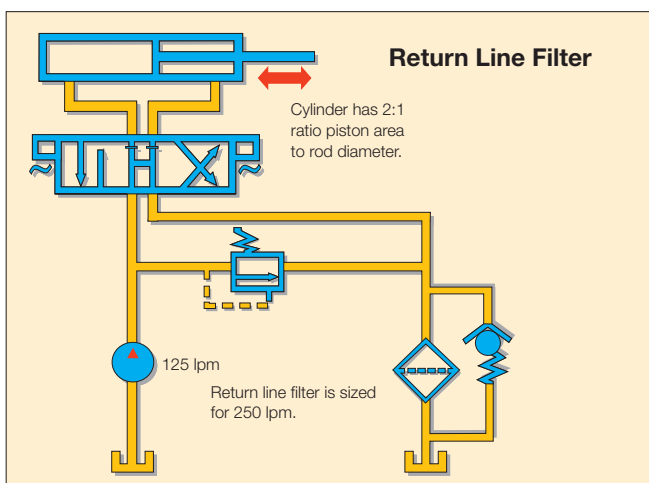

Types & Locations of Filters

Off-Line Filtration



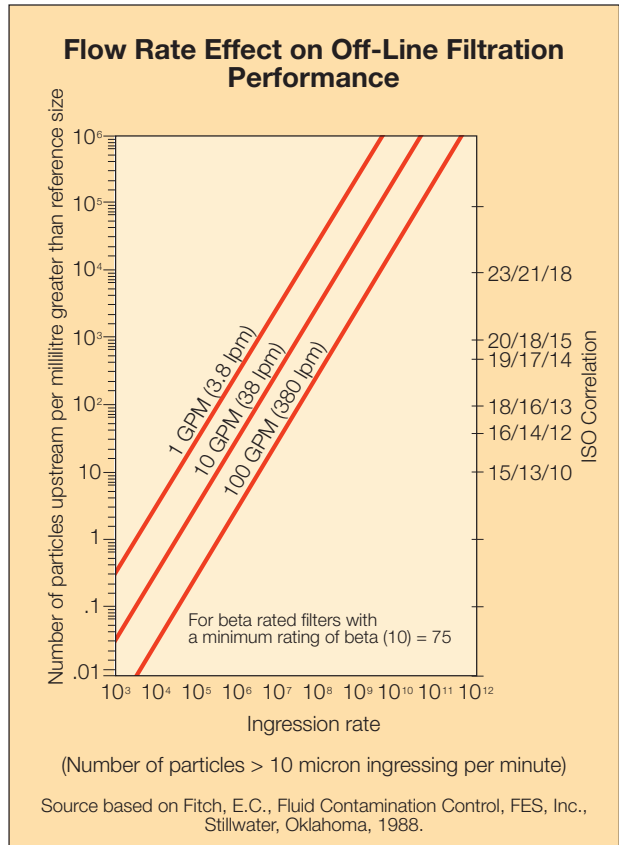
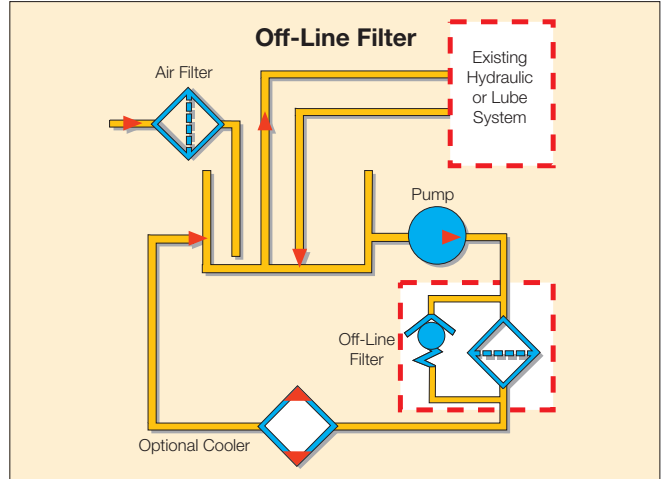

Also referred to as recirculating, kidney loop, or auxiliary filtration, this filtration system is totally independent of a machine's main hydraulic system. Off-line filtration consists of a pump, filter, electrical motor, and the appropriate hardware connections. These components are installed off-line as a small sub-system separate from the working lines, or included in a fluid cooling loop. Fluid is pumped out of the reservoir, through the filter, and back to the reservoir in a continuous fashion. With this "polishing" effect, off-line filtration is able to maintain a fluid at a constant contamination level. As with a return line filter, this type of system is best suited to maintain overall cleanliness, but does not provide specific component protection. An off-line filtration loop has the added advantage that it is relatively easy to retrofit on an existing system that has inadequate filtration. Also, the filter can be serviced without shutting down the main system. Most systems would benefit greatly from having a combination of suction, pressure, return, and off-line filters. The table on the opposite page may be helpful in making a filtration location decision.



Filtration Fact

The cleanliness level of a system is directly proportional to the flow rate over the system filters.

Comparison of Filter Types and Locations

Filter Location	Advantages	Disadvantages
Air Filter 	<ul style="list-style-type: none"> • By preventing initial ingress, removal by the system filter is not needed. • High capacity. • Easy access for servicing. • Cost effective. • Environmentally friendly • Can be used to remove both particulates and water. 	<ul style="list-style-type: none"> • Initial cost • Location can encourage damage • Oil leakage
Suction (Externally Mounted) 	<ul style="list-style-type: none"> • Last chance protection for the pump. • Much easier to service than a sump strainer. 	<ul style="list-style-type: none"> • Must use relatively coarse media, and/or large housing size, to keep pressure drop low due to pump inlet conditions. • Cost is relatively high. • Does not protect downstream Components from pump wear debris. • May not be suitable for many variable volume pumps. • Minimum system protection.
Pressure 	<ul style="list-style-type: none"> • Specific component protection • Contributes to overall system cleanliness level. • Can use high efficiency, fine filtration, filter elements. • Catches wear debris from pump 	<ul style="list-style-type: none"> • Housing is relatively expensive because it must handle full system pressure. • Does not catch wear debris from downstream working components.
Return 	<ul style="list-style-type: none"> • Catches wear debris from components, and dirt entering through worn cylinder rod seals before it enters the reservoir. • Lower pressure ratings result in lower costs. • May be in-line or in-tank for easier installation. • Relative initial cost is low. 	<ul style="list-style-type: none"> • No protection from pump generated contamination. • Return line flow surges may reduce filter performance. • No direct component protection.
Off-Line 	<ul style="list-style-type: none"> • Continuous “polishing” of the main system hydraulic fluid, even if the system is shut down. • Servicing possible without main system shut down. • Filters not affected by flow surges allowing for optimum element life and performance. • The discharge line can be directed to the main system pump to provide supercharging with clean, conditioned fluid. • Specific cleanliness levels can be more accurately obtained and maintained. • Fluid cooling may be easily incorporated. 	<ul style="list-style-type: none"> • Relative initial cost is high. • Requires additional space. • No direct component protection.

Fluid Analysis

Filter Types & Locations

- Patch Test
- Portable Particle Counter
- Laboratory Analysis

Fluid analysis is an essential part of any maintenance programme. Fluid analysis ensures that the fluid conforms to manufacturer specifications, verifies the composition of the fluid, and determines its overall contamination level.

Filtration Fact

Any fluid analysis should always include a particle count and corresponding ISO code.



Portable Particle Counter

The most important development within the field of fluid system maintenance is the Portable Particle Counter. Developed to allow on site, rapid identification of the levels of particulates in systems, these instructions are now the accepted way of monitoring levels of solids in fluid systems.

Capable of accurately and repeatedly reporting levels of particulates down to 2 microns in size, they are also lightweight, portable and reliable.

With a test taking typically 2 minutes, laser particle counters offer portable counts and cleanliness codes. Usually ISO and NAS.

For water content, viscosity and spectrometer analysis, samples should be sent to a certified laboratory.

Laboratory Analysis

The laboratory analysis is a complete look at a fluid sample. Most qualified laboratories will offer the following tests and features as a package:

- Viscosity at 90°C
- Viscosity at 100°C
- Viscosity Index
- Neutralisation number
- Water content
- Particle counts
- Spectrometric analysis (wear metals and additive analysis reported in parts per million, or ppm)
- Trending graphs
- Photo micrograph
- Recommendations

In taking a fluid sample from a system, care must be taken to make sure that the fluid sample is representative of the system.

To accomplish this, the fluid must be drawn into a certified clean container the fluid must be correctly extracted from the system.

When it is impossible to run an on-line analysis, it is acceptable to drain fluid into a clean container, for analysis away from site. ISO 4021 (1992) is the accepted standard for extracting fluid samples from an operating hydraulic fluid system and should be followed at all times.



The goal is a representative fluid sample, one which, as closely as possible, reflects the condition of the system fluid.

- 1st The system should have been at operating temperature for at least 30 minutes before the sample is taken.
- 2nd Sampling valves should be opened and flushed for at least 15 seconds.
- 3rd The clean sample bottle should be kept sealed until the fluid and valve are ready for sampling.

A complete procedure follows in the appendix.

Filtration Fact

The only way to know the condition of a fluid is through fluid analysis. Visual examination is not an accurate method.

Appendix

Sampling Procedure

Obtaining a fluid sample for particle counts and / or analysis involves important steps to make sure you are getting a representative sample. Often erroneous sampling procedures will disguise the true nature of system cleanliness levels. Use one of the following methods to obtain a representative system sample.

This is applicable whether on line or bottle sampling is being done. However, bottle sampling is particularly susceptible to error, due to the number of opportunities for contaminants to enter the samples.

1. For systems with a sampling valve

- A. Operate system for at least 30 minutes.
- B. With the system operating, open the sample valve allowing 200ml to 500 ml (7 to 16 ounces) of fluid to flush the sampling port. (The sample valve design should provide turbulent flow through the sampling port.)
- C.1. Online Sampling
Connect the online particle counter and run samples until a minimum of 3 consecutive comparable samples are obtained.
- C.2. Bottle Sampling
Using a wide mouth, pre-cleaned sampling bottle, remove the bottle cap and place in the stream of flow from the sampling valve. Do NOT “rinse” out the bottle with initial sample. Do not fill the bottle more than 80% full.
- D. Close the sample bottle immediately. Next, close the sampling valve. (Make prior provision to “catch” the fluid while removing the bottle from the stream.)
- E. Label the sample bottle with pertinent data: include date, machine number, fluid supplier, fluid number code, fluid type, and time elapsed since last sample (if any).

2. Systems without a sampling valve

- A. Operate the system for at least 30 minutes.
- B. Use a small hand-held vacuum pump bottle thief or “basting syringe” to extract sample. Insert sampling device into the tank to one half of the fluid height. You will probably have to weight the end of the sampling tube. Your objective is to obtain a sample in the middle portion of the tank. Do not let the syringe or tubing come into contact with the side of the tank.
- C. Put extracted fluid into an approved, pre-cleaned sample bottle as described in the sampling valve method above.
- D. Cap immediately
- E. Label with information as described in sampling valve method.



Regardless of the method being used, observe common sense rules. Any equipment which is used in the fluid sampling procedure must be washed and rinsed with a filtered solvent. This includes vacuum pumps, syringes and tubing. Your goal is to count only the particles already in the system fluid. Dirty sampling devices and non-representative samples will lead to erroneous conclusions and cost more in the long run.

Appendix

Parker Cleanliness Service Report Example

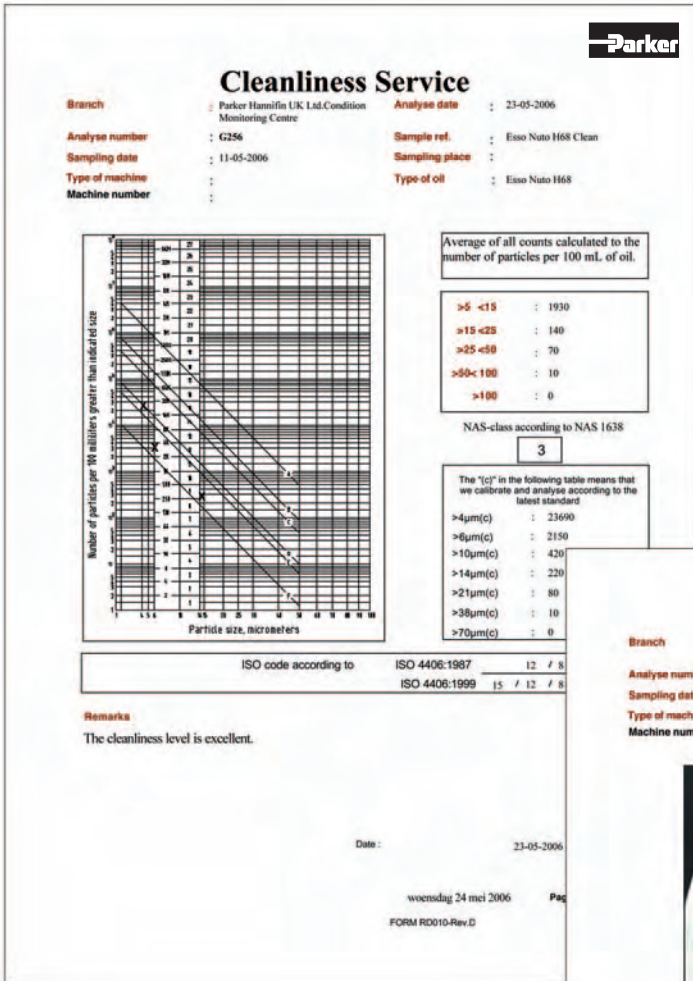

Filtration Fact

Rule of thumb: size the pump flow of an off-line package at a minimum of 10% of the main reservoir volume.

Contamination Control Solutions

Knowing how contaminated your oil is and knowing how to clean it to approved standards are key issues but with simple solutions.

Do you know how dirty your oil is?

Parker Filtration has the cost effective solutions. Hand-held Oilcheck to monitor oil cleanliness, Guardian portable filter systems and Par-Fit interchange replacement elements - quality products and effective solutions to reduce equipment downtime caused by fluid contamination.

3 Parker Filtration Products With One Aim

Parker Oilcheck know the condition of the oil in your system

With Parker Oilcheck, you can check your oil condition any time, any place and anywhere. Hand-held oilcheck provides an operator with a comparison between new and used oils and potentially gives a warning of impending engine failure. Parker Oilcheck will save you money and reduce the risk of equipment downtime.



Parker Guardian The first line of defence in protecting your hydraulic System against contamination.

The Guardian portable filtration system is a unique pump/motor/filter combination designed for transferring mineral, conditioning petroleum-based and water emulsion fluids. It will protect your system from contamination ingress when adding new fluid, because new fluid is not necessarily clean fluid.

The Guardian is a supremely robust and portable filtration system that will assist in defending a hydraulic system from particulate and or water contamination, removing particulate down to 2μ when fitted with the appropriate dedicated element. The guardian is ideal as an offline filtration/conditioning system on your hydraulic system reservoir.

Parker Par-Fit

Parker Filtration's quality range of interchangeable hydraulic elements numbers in the thousands.

Genuine Parker elements are available for almost every manufacturer in the world and that quality in manufacture can very often mean that Parker element performs to a higher standard than the original it is replacing.

Visit the Par-Fit online element selector at www.parker.com/parfit and discover for yourself just how extensive our range of interchangeable elements is. That's why we say 'Fit Par-Fit Fit Quality.



Common Conversions

To Convert	Into....	Multiply by....
------------	----------	-----------------

Pressure		
Atmosphere	Bar	1.01325
Atmosphere	PSI	14.69595
Atmosphere	Ins Hg	29.92126
Bar	Kg/sq Metre	10,200
Bar	PSI	0.069
Millibar	Ins Hg	0.02952999
Pascal (Pa)	Bar	0.00001
Pascal (Pa)	PSI	0.000145

Distance		
Centimetres	Feet	30.48
Centimetres	Inches	2.54
Metres	Feet	3.28083
Metres	Inches	39.36996
Metres	Yards	1.09361
Microns	Inches	0.000039
Microns	Metre	0.000001
Microns	Millimetre	0.0001
Millimetres	Feet	0.00328083
Millimetres	Inches	0.03937

Energy		
Kilojoule	Horsepower	0.0003725061
Kilowatt	Horsepower	1.341022
Newton Metre	Inch pound (lb)	8.850746
Newton Metre	Foot pound(lb)	23.73036

Temperature		
Celcius	Fahrenheit	((OC x 9.5)+32)
Celcius	Kelvin	OC + 273.15
Fahrenheit	Kelvin	255.9278

Volume		
Cubic Centimetres	Cubic Feet	0.00003521
Cubic Centimetres	Cubic Inches	0.06102
Cubic Centimetres	Litres	0.000001
Cubic Centimetres	US Gallons	0.0002642
Cubic Metres	Cubic Feet	35.310
Cubic Metres	Cubic Inches	61,023
Cubic Metres	Litres	1,000
Cubic Metres	US Gallons	264.20
Litres	Cubic Centimetres	1,000
Litres	Cubic Feet	0.035315
Litres	Cubic Inches	61.0234
Litres	Gallons	0.220083
Litres	US Gallons	0.264170
Litres / Min	Cubic Centimetres / Min	1,000
Litres / Min	Cubic Feet / Min	0.035
Litres / Min	Gallons / Min	0.264

Mass		
Grams	Pounds (lb)	0.0022046
Kilograms	Grams	1,000
Kilograms	Pounds (lb)	2.20462
Tonnes (t)	Tons (tn)	1.102311

Area		
Centimetre ²	Inch ²	1,550,003
Centimetre ²	Foot ²	0.001076391
Centimetre ²	Yard ²	0.000119599
Kilometre ²	Inch ²	155003e +009
Kilometre ²	Foot ²	1076391e +007
Kilometre ²	Yard ²	1,195,990
Metre ²	Inch ²	1,550,003
Metre ²	Foot ²	10.76391
Metre ²	Yard ²	1.19599

To Convert	Into....	Multiply by....
------------	----------	-----------------

Pressure		
Bar	Atmosphere	0.9869233
PSI	Atmosphere	0.06804596
Ins Hg	Atmosphere	0.03342105
Kg/sq Metre	Bar	9.80665E-05
PSI	Bar	14.50
Ins Hg	Millibar	33.86388
Bar	Pascal (Pa)	100,000
PSI	Pascal (Pa)	6,894.747

Distance		
Feet	Centimetres	0.0328083
Inches	Centimetres	0.394
Feet	Metres	0.3048
Inches	Metres	0.0254
Yards	Metres	0.9144
Inches	Microns	25,400
Metre	Microns	1,000,000
Millimetre	Microns	1,000
Feet	Millimetres	394.800
Inches	Millimetres	25.40

Energy		
Horsepower	Kilojoule	2,684.52
Horsepower	Kilowatt	0.7456999
Inch pound (lb)	Newton Metre	0.1129848
Foot pound(lb)	Newton Metre	1.355818

Temperature		
Fahrenheit	Celcius	(OF - 32) / 1.8
Kelvin	Celcius	OK - 273.15
Kelvin	Fahrenheit	-457.866

Volume		
Cubic Feet	Cubic Centimetres	28,316.85
Cubic Inches	Cubic Centimetres	16.38706
Litres	Cubic Centimetres	1,000
US Gallons	Cubic Centimetres	3,785.412
Cubic Feet	Cubic Metres	0.02831685
Cubic Inches	Cubic Metres	1.638706E-05
Litres	Cubic Metres	0.001
US Gallons	Cubic Metres	0.00378541
Cubic Centimetres	Litres	0.001
Cubic Feet	Litres	28.31685
Cubic Inches	Litres	0.01638706
Gallons	Litres	4,544
US Gallons	Litres	3.785
Cubic Centimetres / Min	Litres / Min	0.001
Cubic Feet / Min	Litres / Min	28.31685
Gallons / Min	Litres / Min	4.546092

Mass		
Pounds (lb)	Grams	453.5924
Grams	Kilograms	0.001
Pounds (lb)	Kilograms	0.4535924
Tons (tn)	Tonnes (t)	0.9071847

Area		
Inch ²	Centimetre ²	6.4516
Foot ²	Centimetre ²	929.0304
Yard ²	Centimetre ²	8,361.274
Inch ²	Kilometre ²	6.4516e -010
Foot ²	Kilometre ²	9.290304e -008
Yard ²	Kilometre ²	8.361274e -007
Inch ²	Metre ²	0.00064516
Foot ²	Metre ²	0.09290304
Yard ²	Metre ²	0.8361274

The Choice is Perfectly Clear

AE – United Arab Emirates
Abu Dhabi
Tel: +971 2 67 88 587

AR – Argentina
Buenos Aires
Tel: +54 3327 44 4129

AT – Austria
Wiener Neustadt
Tel: +43 (0)2622 23501
Austria (Eastern Europe)
Wiener Neustadt
Tel: +43 (0)2622 23501-970

AU – Australia
Castle Hill
Tel: +61 (0)2-9634 7777

AZ – Azerbaijan
Baku
Tel: +99 412 598 3966

BE – Belgium
Nivelles
Tel: +32 (0)67 280 900

BR – Brazil
Cachoeirinha RS
Tel: +55 51 3470 9144

BY – Belarus
Minsk
Tel: +375 17 209 9399

CA – Canada
Milton, Ontario
Tel: +1 905-693-3000

CH – Switzerland
Ref. Germany

CN – China
Beijing
Tel: +86 10 6561 0520
Shanghai
Tel: +86 21 5031 2525

CZ – Czech Republic
Klecany
Tel: +420 284 083 111

DE – Germany
Kaarst
Tel: +49 (0)2131 4016 0

DK – Denmark
Ballerup
Tel: +45 4356 0400

ES – Spain
Madrid
Tel: +34 91 675 73 00

FI – Finland
Vantaa
Tel: +358 20 753 2500

FR – France
Contamine-sur-Arve
Tel: +33 (0)450 25 80 25

GR – Greece
Athens
Tel: +30 210 933 6450

HK – Hong Kong
Tel: +852 2428 8008

HU – Hungary
Budapest
Tel: +36 1 220 4155

IE – Ireland
Dublin
Tel: +353 (0)1 466 6370

IN – India
Mumbai
Tel: +91 22 5613 7081/82-85

IT – Italy
Corsico (MI)
Tel: +39 02 45 19 21

JP – Japan
Tokyo
Tel: +81 3 6408 3900

KR – South Korea
Seoul
Tel: +82 2 559 0400

KZ – Kazakhstan
Almaty
Tel: +7 3272 505 800

LV – Latvia
Riga
Tel: +371 74 52601

MX – Mexico
Apodaca
Tel: +52 81 8156 6000

MY – Malaysia
Subang Jaya
Tel: +60 3 5638 1476

NL – The Netherlands
Oldenzaal
Tel: +31 (0)541 585000

NO – Norway
Ski
Tel: +47 64 91 10 00

NZ – New Zealand
Mt Wellington
Tel: +64 9 574 1744

PL – Poland
Warsaw
Tel: +48 22 573 24 00

PT – Portugal
Leça da Palmeira
Tel: +351 22 9997 360

RO – Romania
Bucharest
Tel: +40 21 252 1382

RU – Russia
Moscow
Tel: +7 495 580 9145
Krasnoyarsk
Tel: +7 3912 52 73 35
Yuzhno-Sakhalinsk
Tel: +7 4242 42 35 27
St. Petersburg
Tel: +7 812 320 49 37

SE – Sweden
Spånga
Tel: +46 (0)8 597 950 00

SG – Singapore
Tel: +65 6887 6300

SI – Slovenia
Novo Mesto
Tel: +386 7 337 6650

SK – Slovakia
Ref. Czech Republic

TH – Thailand
Bangkok
Tel: +662 717 8140

TR – Turkey
Merter/Istanbul
Tel: +90 212 482 91 06 or 07

TW – Taiwan
Taipei
Tel: +8862 2298 8987

UA – Ukraine
Kyiv
Tel: +380 44 494 2731

UK – United Kingdom
Warwick
Tel: +44 (0)1926 317 878

US – USA
Cleveland (industrial)
Tel: +1 216-896-3000
Lincolnshire (mobile)
Tel: +1 847-821-1500
Miami (Pan American Div.)
Tel: +305 470 8800

VE – Venezuela
Caracas
Tel: +58 212 238 5422

ZA – South Africa
Kempton Park
Tel: +27 (0)11-961 0700



Filtration website: www.parker.com/eurofilt
Filtration email: filtrationinfo@parker.com
For further information on other Parker Products,
call the EPIC free on 0800 27 27 5374

Brochure Ref: FDHB289UK
Hydraulic Filter Division Europe

© Copyright 2006
Parker Hannifin Corporation
All rights reserved.